

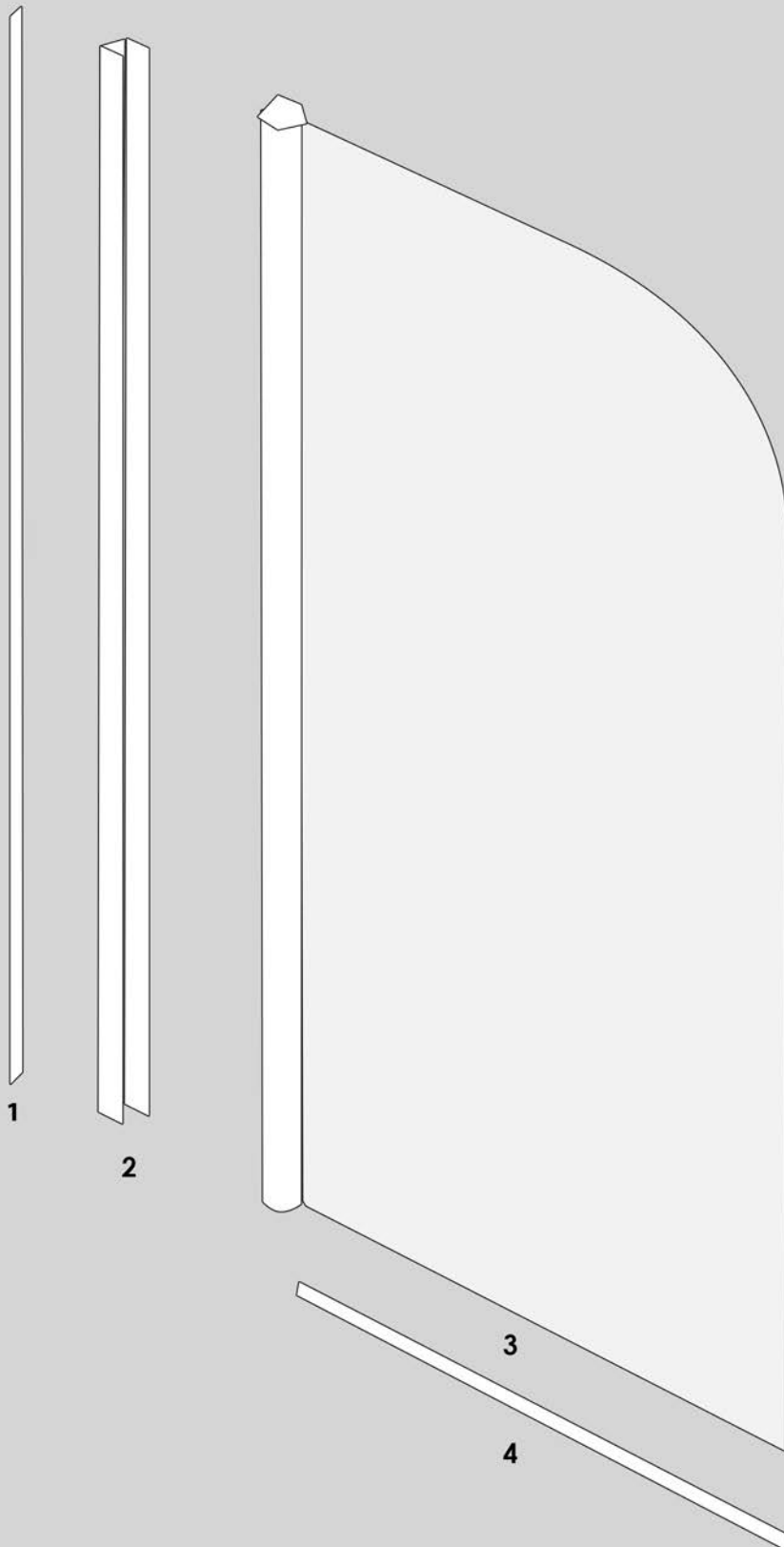







# Installation Instructions

## Vetro Bath Screen



- |          |   |                          |
|----------|---|--------------------------|
| <b>1</b> |  | 1 x Clear Rubber Seal    |
| <b>2</b> |  | 1 x Wall Jamb            |
| <b>3</b> |  | 1 x Door                 |
| <b>4</b> |  | 1 x Water Deflector      |
| <b>5</b> |  | 3 x Wall Plug            |
| <b>6</b> |  | 3 x 30mm Wall Jamb Screw |
| <b>7</b> |  | 3 x Washers              |
| <b>8</b> |  | 3 x Door Screw           |
| <b>9</b> |  | 3 x Chrome Push Caps     |

## Installation Instructions

### Vetro Bath Screen

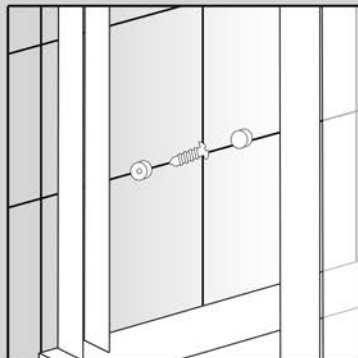
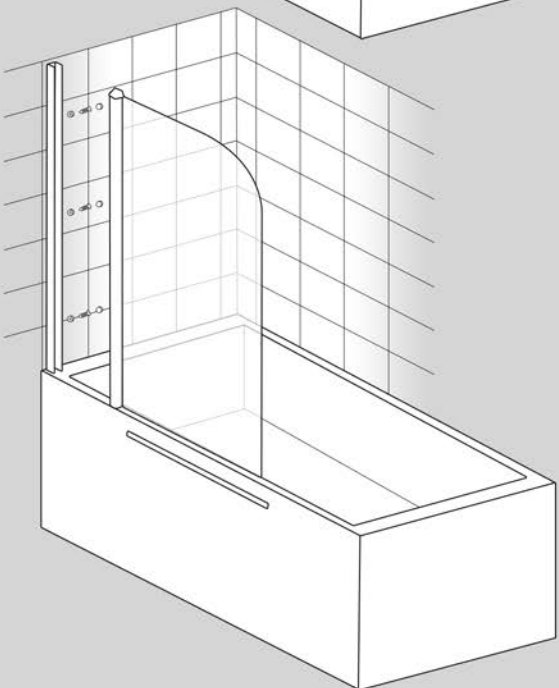
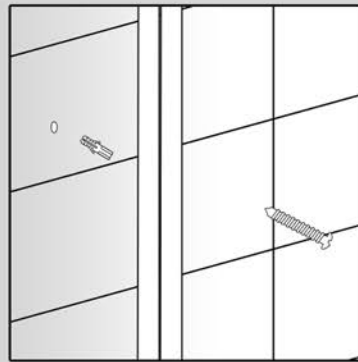
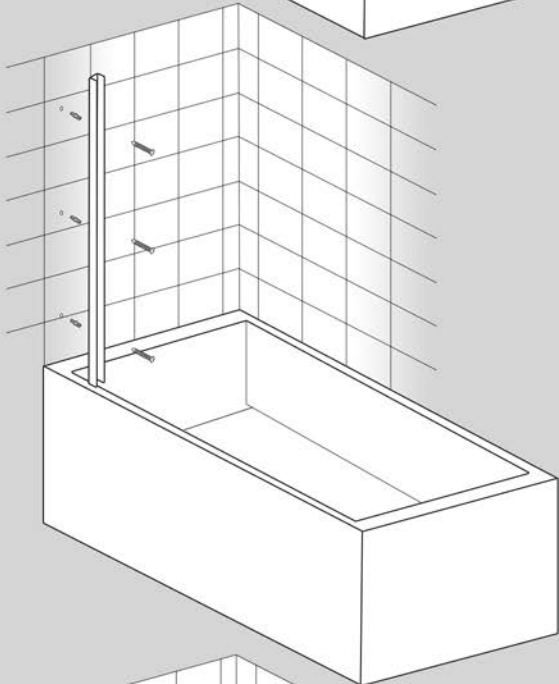
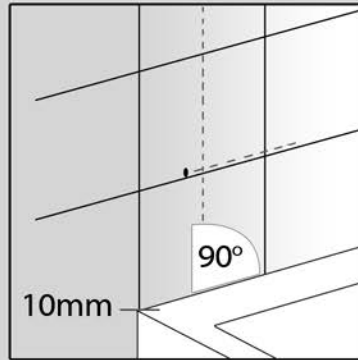
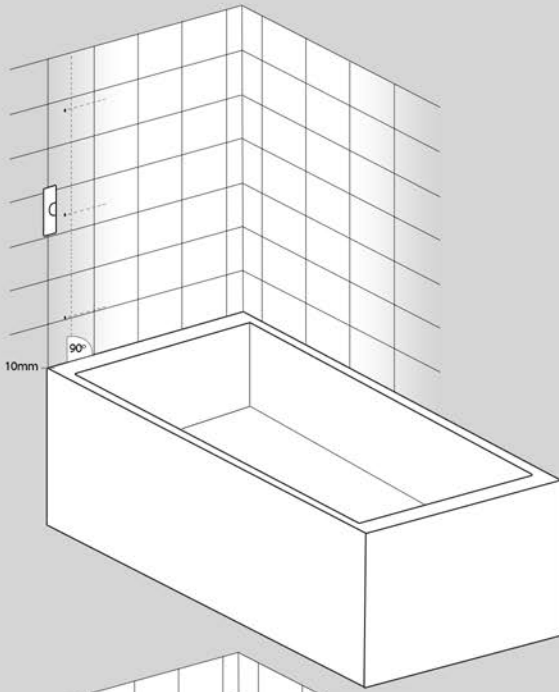

#### Steps A & B

- A. Position the wall jamb(2) inside bath tile lip or if the bath does not have a lip, measure in 10mm from edge and 2mm up from the bath.
- B. Using a spirit level, ensure wall jamb(2) is plumb. Mark position of holes.

#### Steps C & D

- C. Using a suitable drill bit, drill holes and fit wall plugs(5).  
Insert clear rubber seal(1) into rear slot of aluminium wall jamb(2).
- D. Fix wall jamb(2) to stud or noggins using screws(6).  
Please note: If stud or noggin is not available use toggle bolts(not supplied).

#### Steps E & F

- E. Insert Door(3) into wall jamb(2) and secure using door screws(8) with washers(7) and finish with chrome push caps(9).
- F. Slide on Water Deflector(4).